

Tradition

Eco système digital



# The futur is leaving?

« AUJOURD'HUI c'EST DÉJÀ HIER. HIER C'TAIT IL Y A UN SIÈCLE. »

---



# Comment être un être humain dans une si grande ville ?





# MOOD BOARD

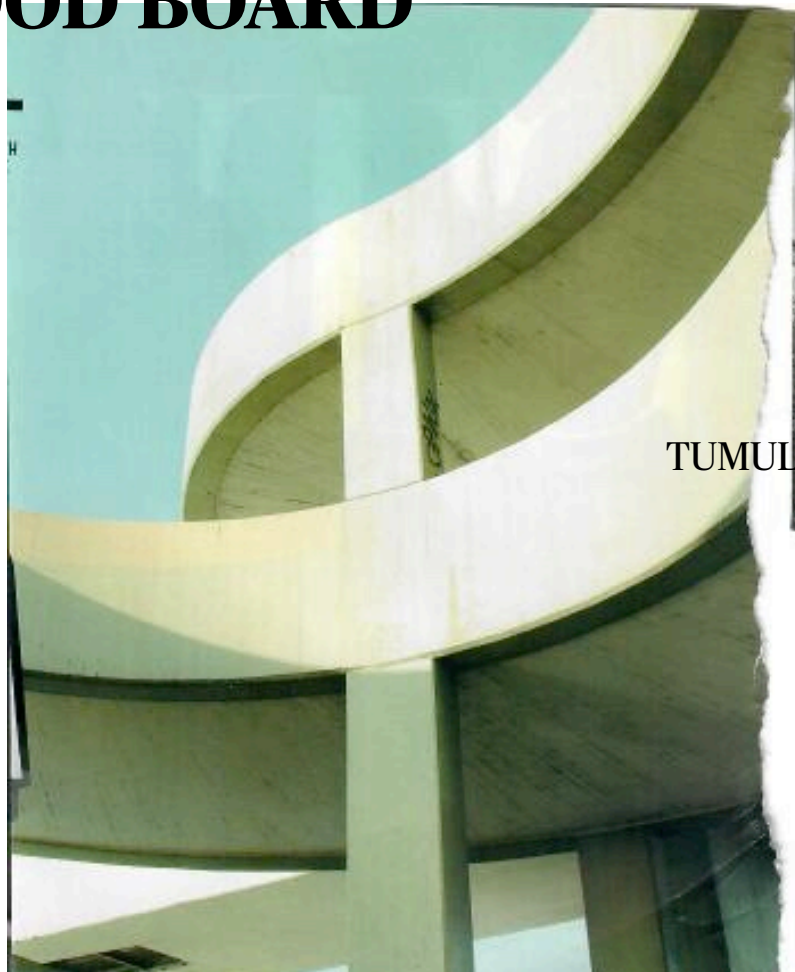

TUMULTE

COSMOPOLITE



LOST

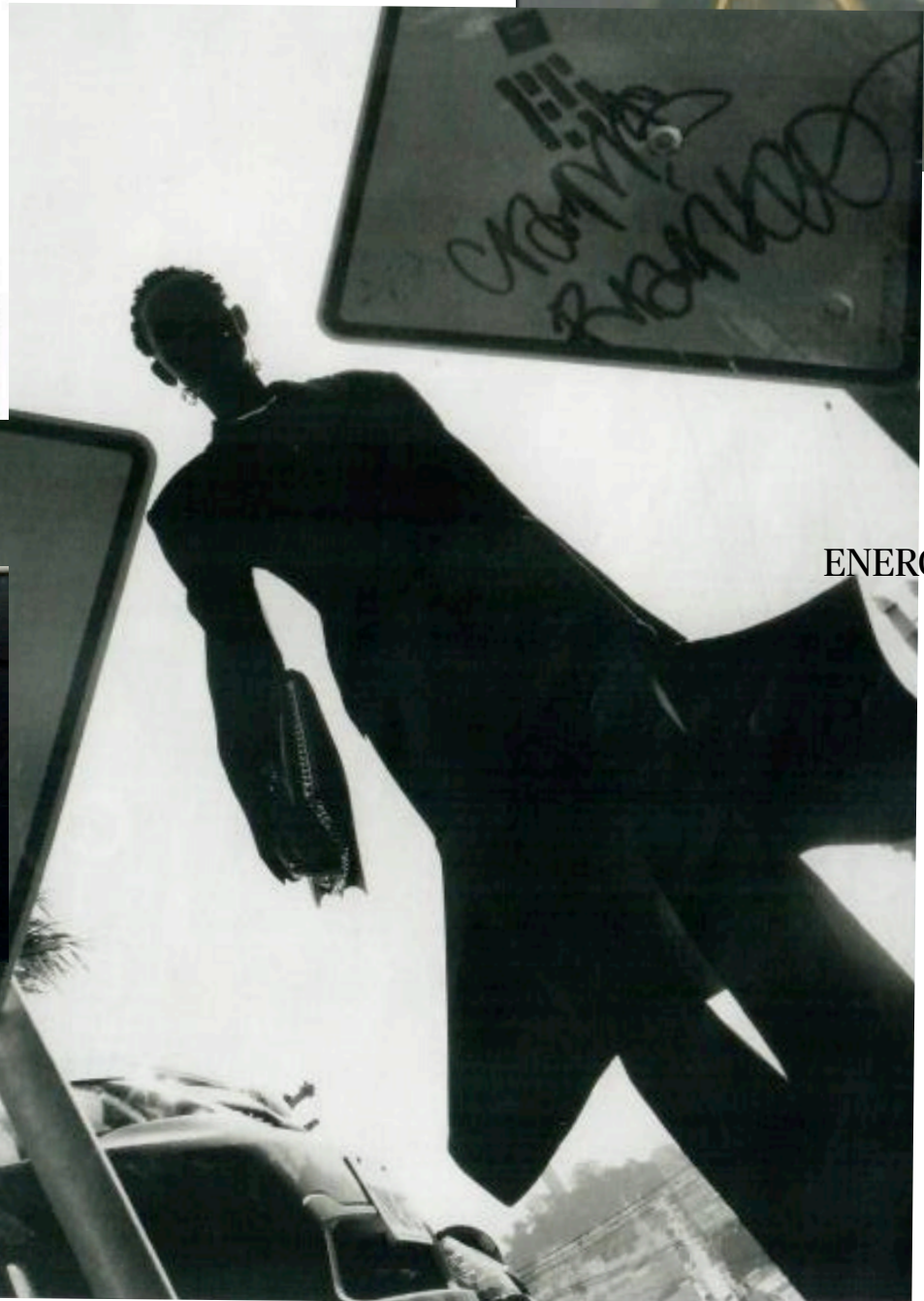

ENERGIE



TRADITION



IDENTITÉE ?



# REVUE DE PRESSE

201

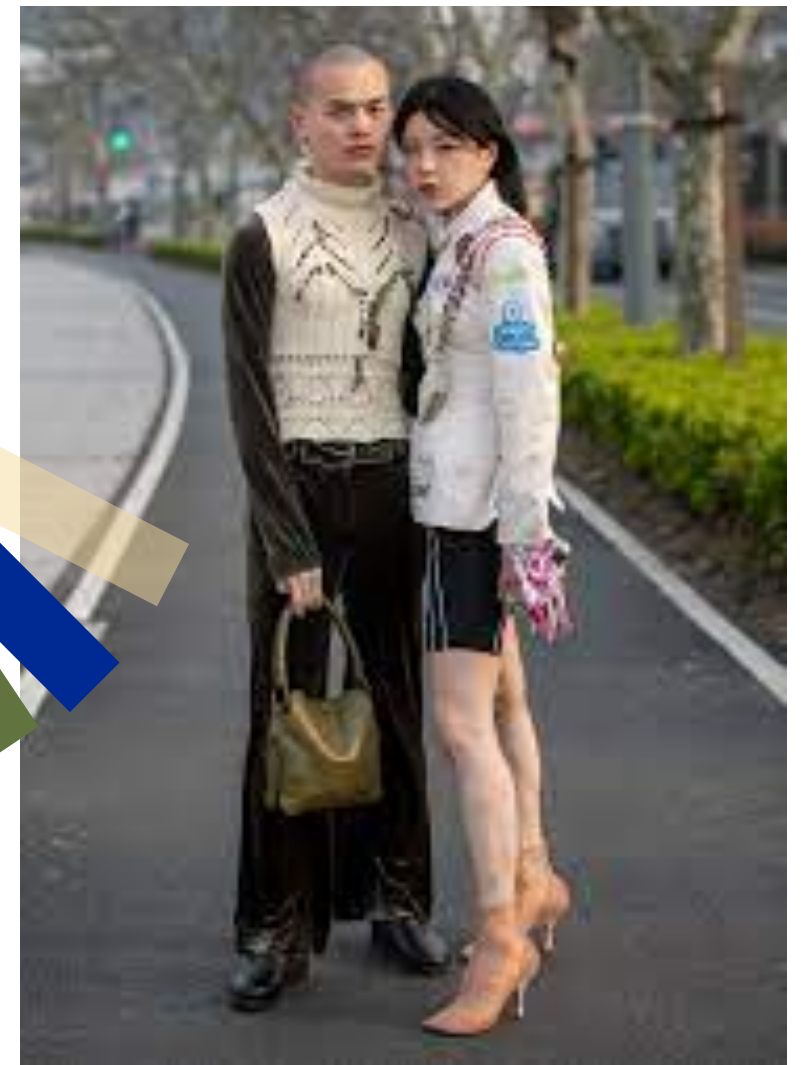
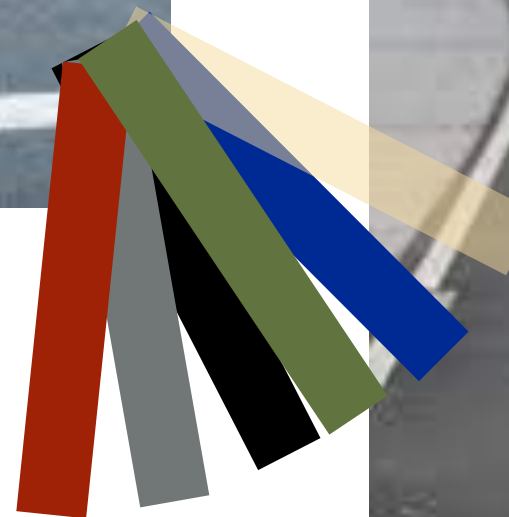

Fashion Street style in Shanghai -  
Dave Taco - WWD



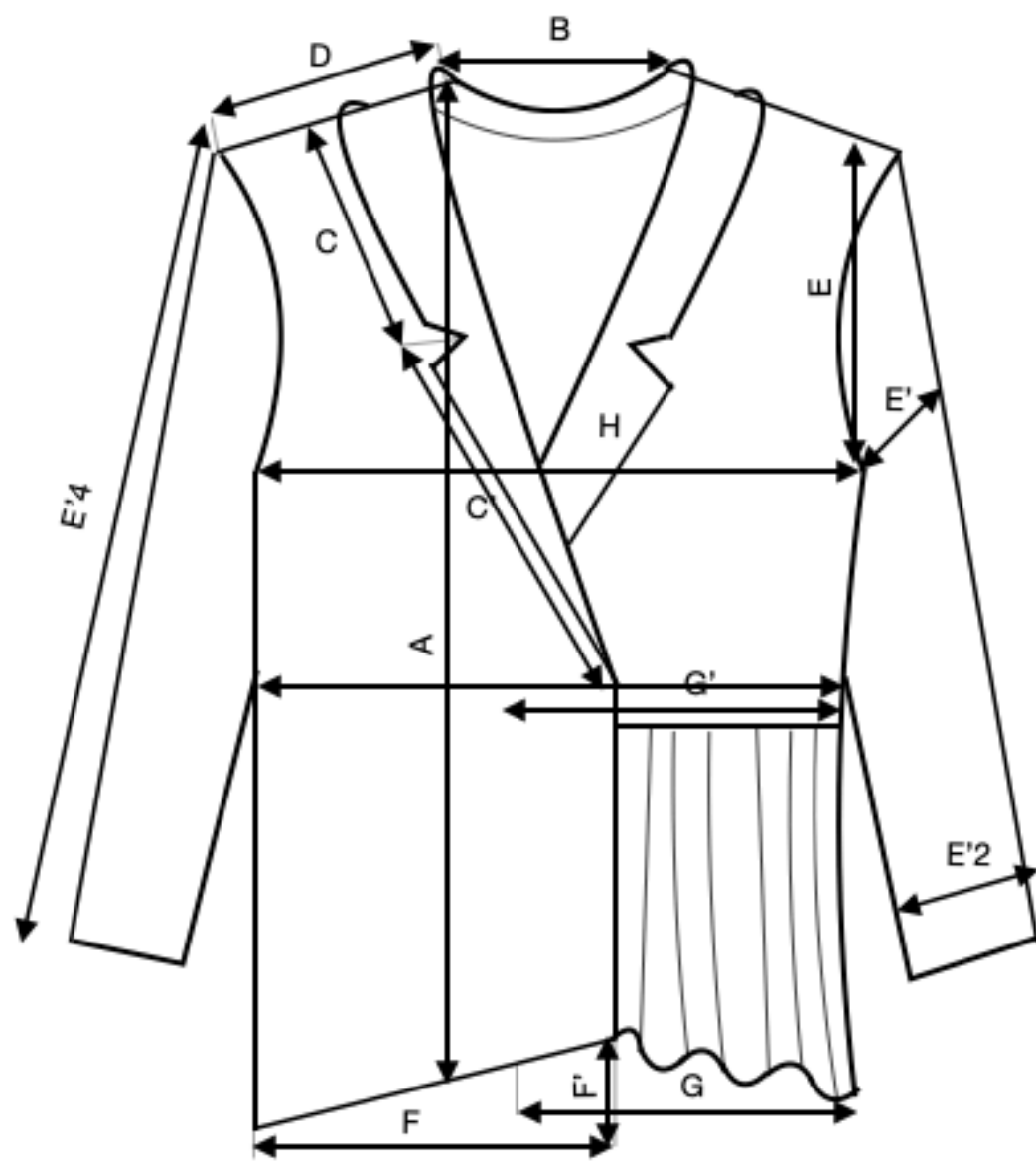

## Veste blazer fermeture croisé

Fermeture croisé avec  
empiècement droit plissé

## FICHE TECHNIQUE//////////

Appellation	Lettre	Mesure	
HSP	A		
Encolure	B		
Haut du col	C		
Bas du col	C'		
Largeur épaule	D		
Enmanchure	E		
Largeur manche à plat	E'		
Poignet	E'2		
Carrure poitrine	H		
Longueur Manche	E'4		
Largeur bas de veste gauche	F		
Largeur bas de veste D plissé	G		
Largeur empiècement plissé	G'		
Hauteur du bas Gauche	F'		



# FONDEMENT DE VIE

Liée par un secret - celui de leur vie auquel elles ont essayer de donner sens et accepté ces codes de la société. Dés à présent elles partent laissant tout, pour se connecté et vivre simplement sans contrainte dans leur présence sont leurs véritable besoin et la compagnie de mère nature et de ces bois, feu, fourrure et soie réconfortante.





NATURE



DÉLICATESSE



FEMME



chaleur

CONNECTION

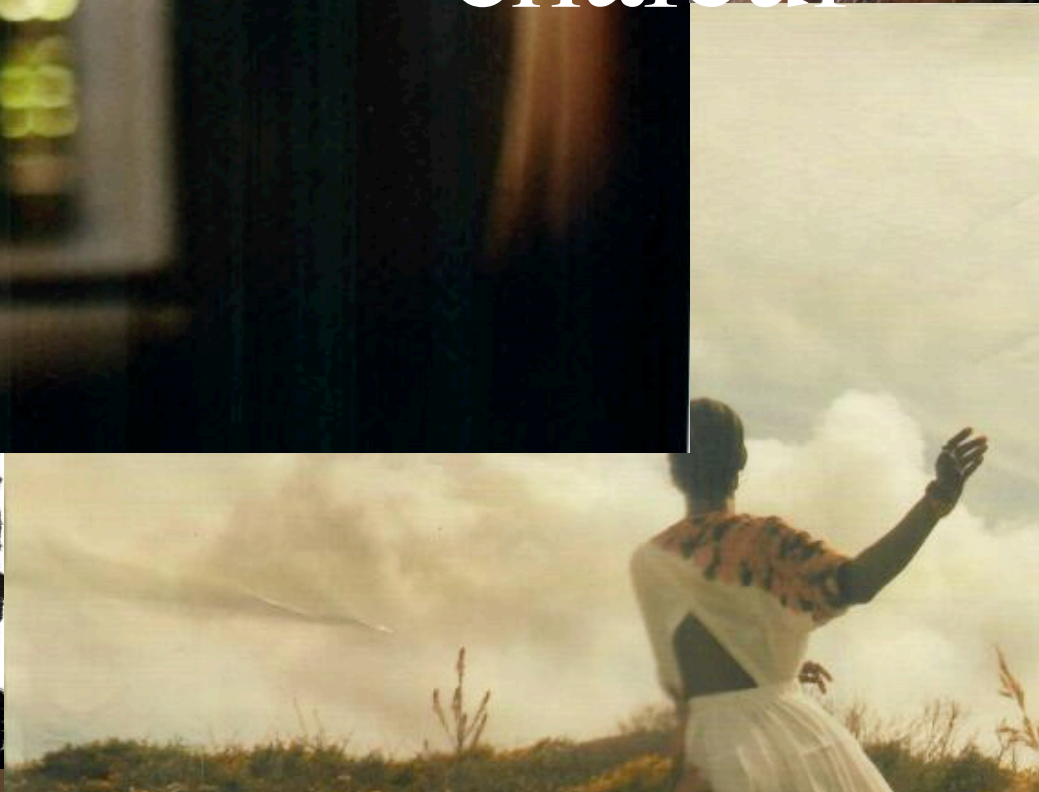
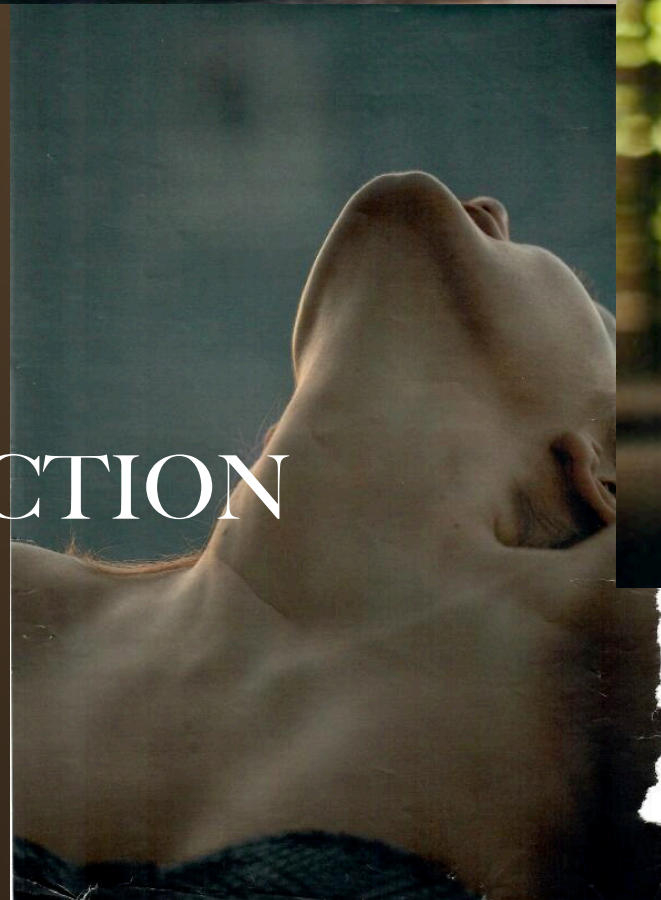



# Revue De Presse



Couleurs





# ÉRANTE

Démunie d'énergie de vivre  
Tourne le dos au monde  
Ce renferme sur eux

Ce n'ai pas la vie qu'il souhaitais, alors la vie ne vos  
pas la peine d'être vécue

Veste et pantalons  
T-shirt et coton  
Paul Smith Jeans  
Basket Nike



# REVUE DE PRESSE

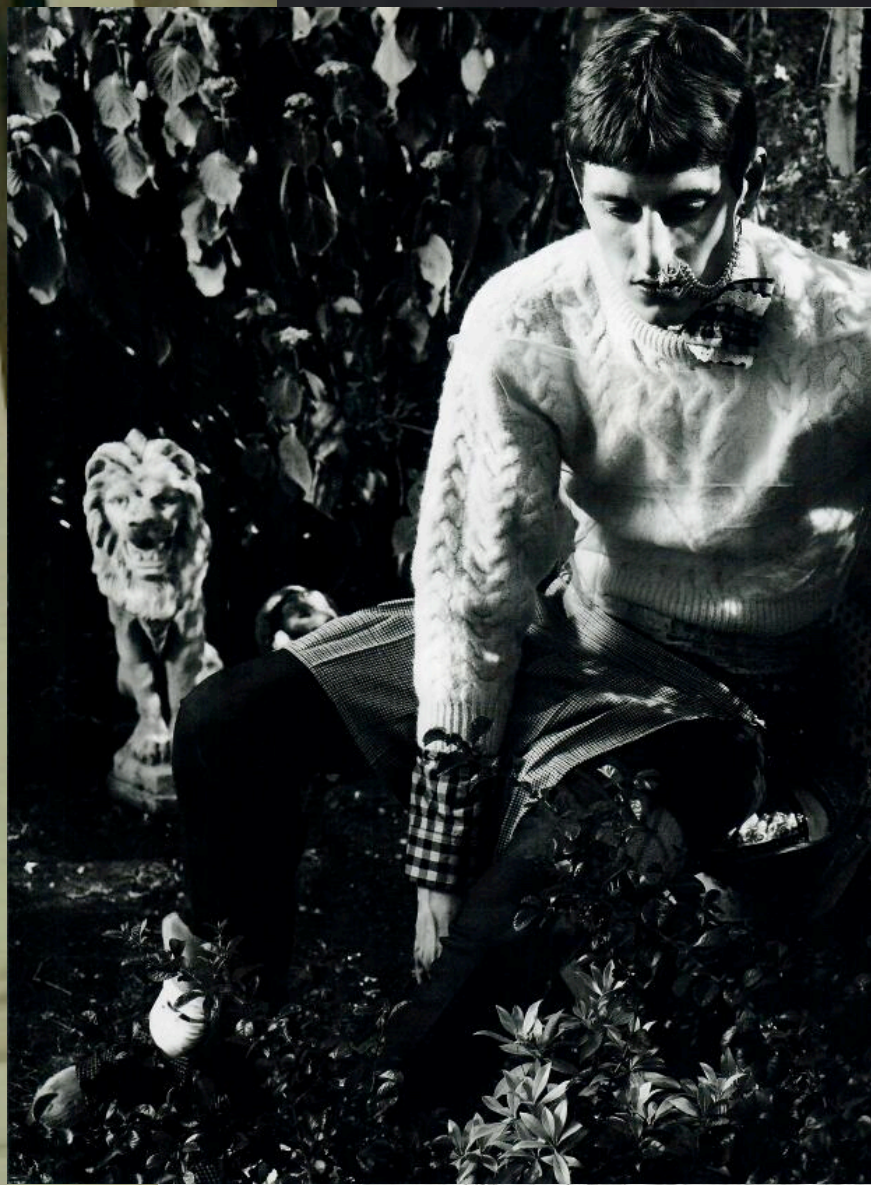

FATIGUE



PERDU



ABSENT

FROID



Monteau et gilet  
sans manches  
en laine Comme  
des Garçons  
Chaussettes  
et t-shirt en coton  
Calvin Klein  
Pantalon en laine  
Cesural  
Chaussures en cuir  
Prada  
Débardeur en  
tulle Studio de  
styliste

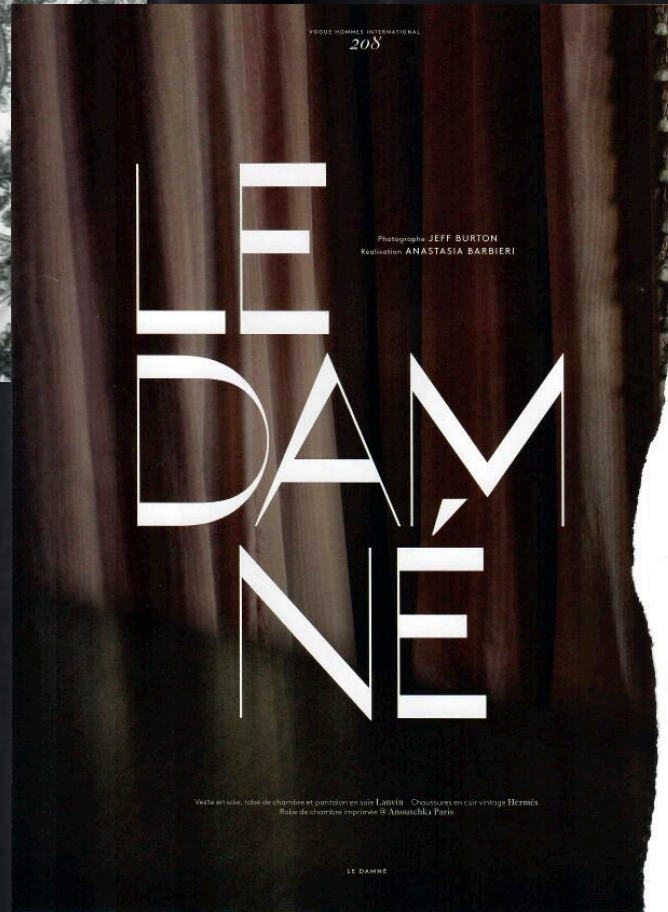

VOYAGE HOMMES INTERNATIONAL  
2018  
Photographie: JEFF BURTON  
Réalisation: ANASTASIA BARBIERI  
**LE  
DAMNÉ**

Voilà en scène, robe de chambre et pantalon en toile Laiton - Chaussures en cuir vintage Hermès  
Robe de chambre inspirée de Annamichka Paris

LE DAMNÉ







# Couleurs

Une gamme perdue  
« érantés »



A contrario de Vivasse

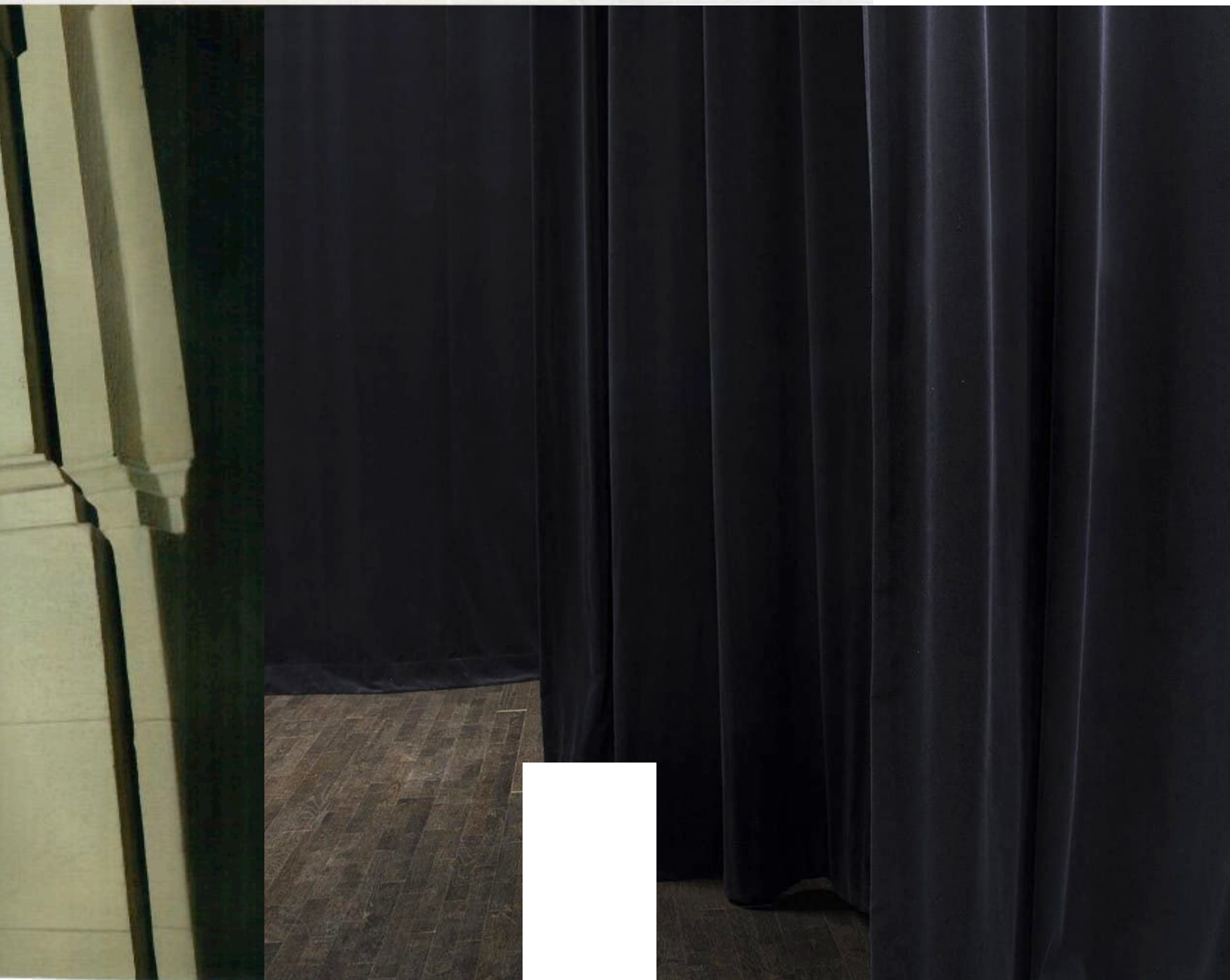

Neutre ? Classic ?

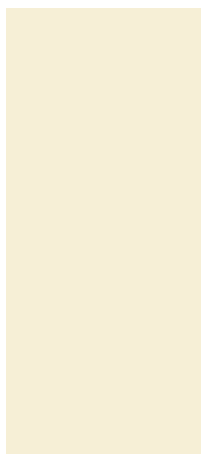

Catégorisé comme  
dépourvue de vie



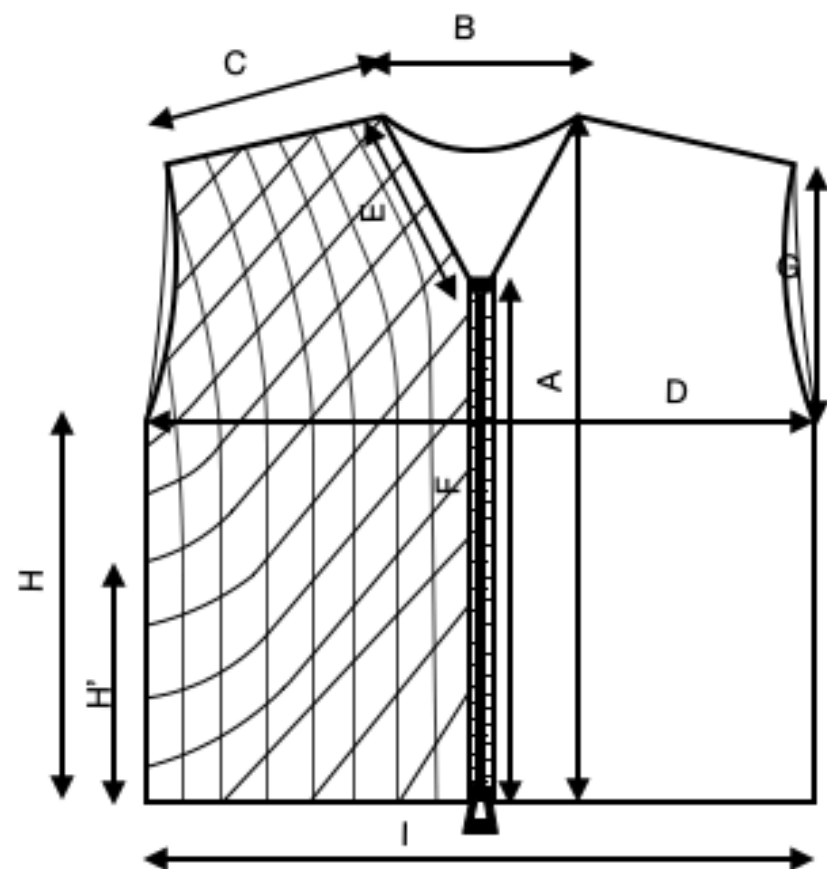

**Gilet sans manches matelasser**



## FICHE TECHNIQUE//////////

Appellation	Lettre	Mesure cm	
HSP	A	70	
Encolure dos	B	24	
Encolure dvt	E	19	
Largeur épaule	C	20	
Enmanchure	G	30	
Carrure poitrine	D	42	
Largeur bas de veste	I	42	
Coté	H	38	
Espacement matelassage	H'	4	
Longueur fermeture à glissière	F	49	





# *Entre boudoir et dancefloor*

SEPTEMBRE 2018

**A**ppeler les comme vous le voudrez, fetard, jeune invétéré, profiteur, ceux qui croque la vie à pleine dents, qui savent profiter de la vie - peu importe car une seule chose est à retenir, c'est qu'il ne s'arrêteront jamais de danser et de vivre pour la fête et la nuit. Juger les et vous aurez comme réponse le plus fascinant vent de votre vie.

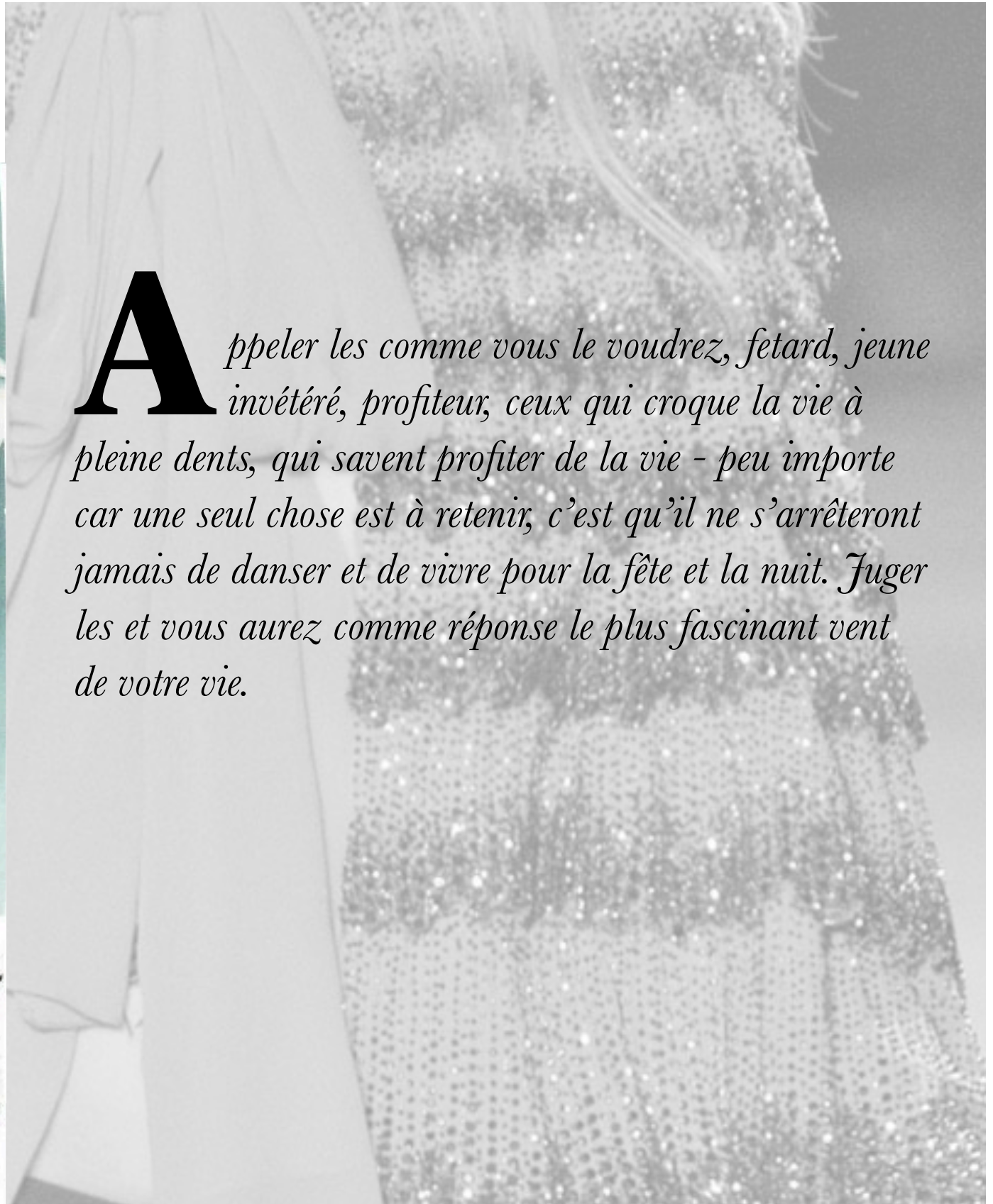



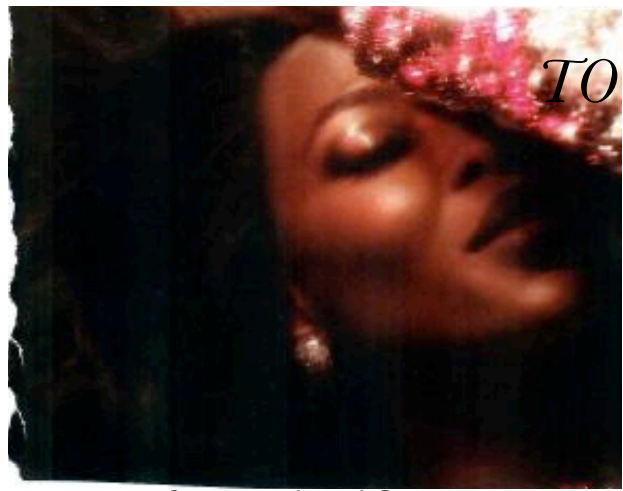

*TOURNIE*

*WILD LIFE*

*SHINING*



*DANCING*



PULL EN MOHAIR,  
PANTALON A SEQUINS  
ET DETAILS EN PLUMES,  
CHAPEAU EN VELOURS,  
ALBERTA FERRETTI.

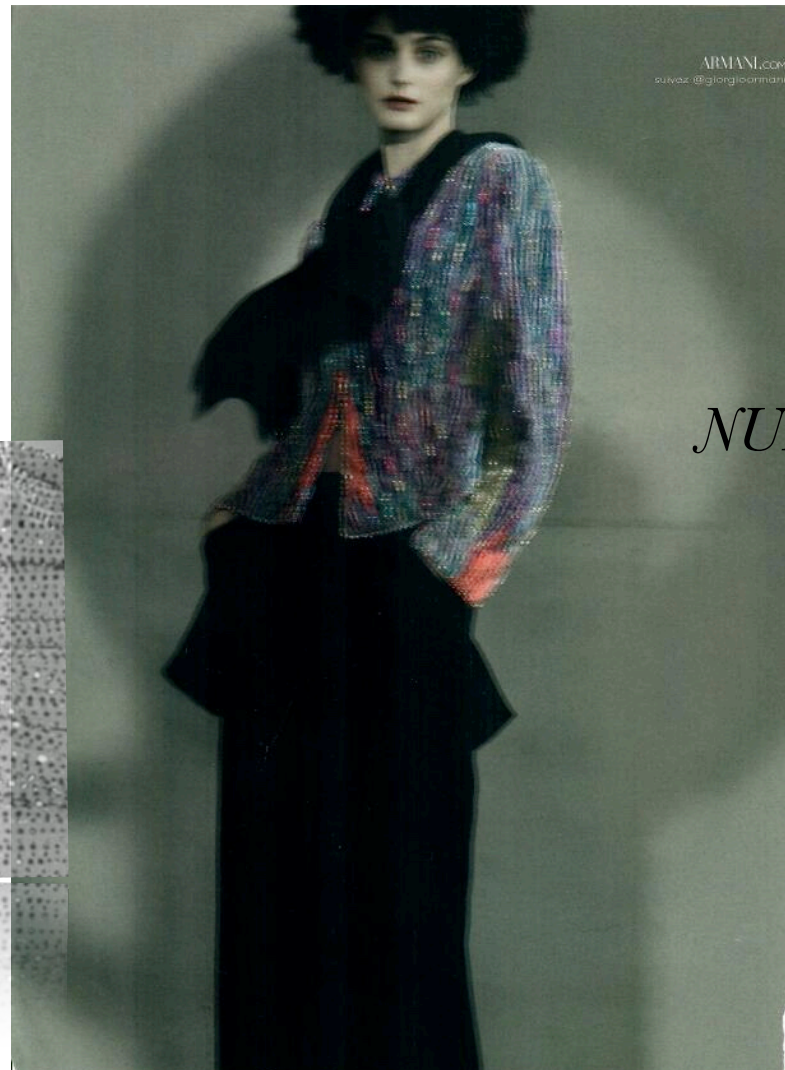
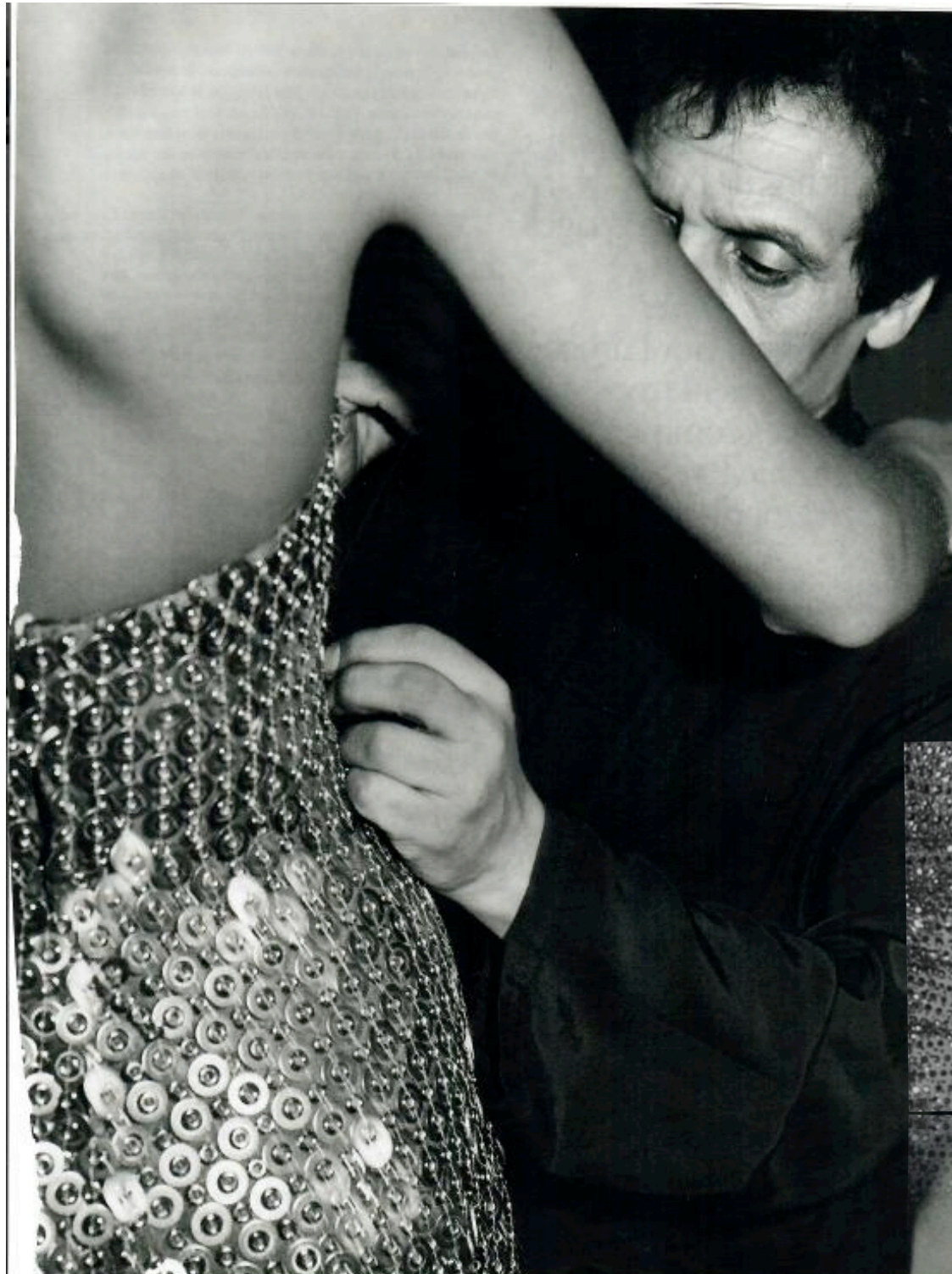

*NUIT*



*ALMOST NON STOP*



# R *EVUE DE PRESSE*





# C OULEURS



**L**amé doré, stass, côte de maille, noir irisé, noir satin, noir mousseline, on techniquement parlant on plus de matières que de couleurs mais ce jeux de lumières pousse notre vision et imaginaire vers un notre univers qui lui créer ses couleur autrement.



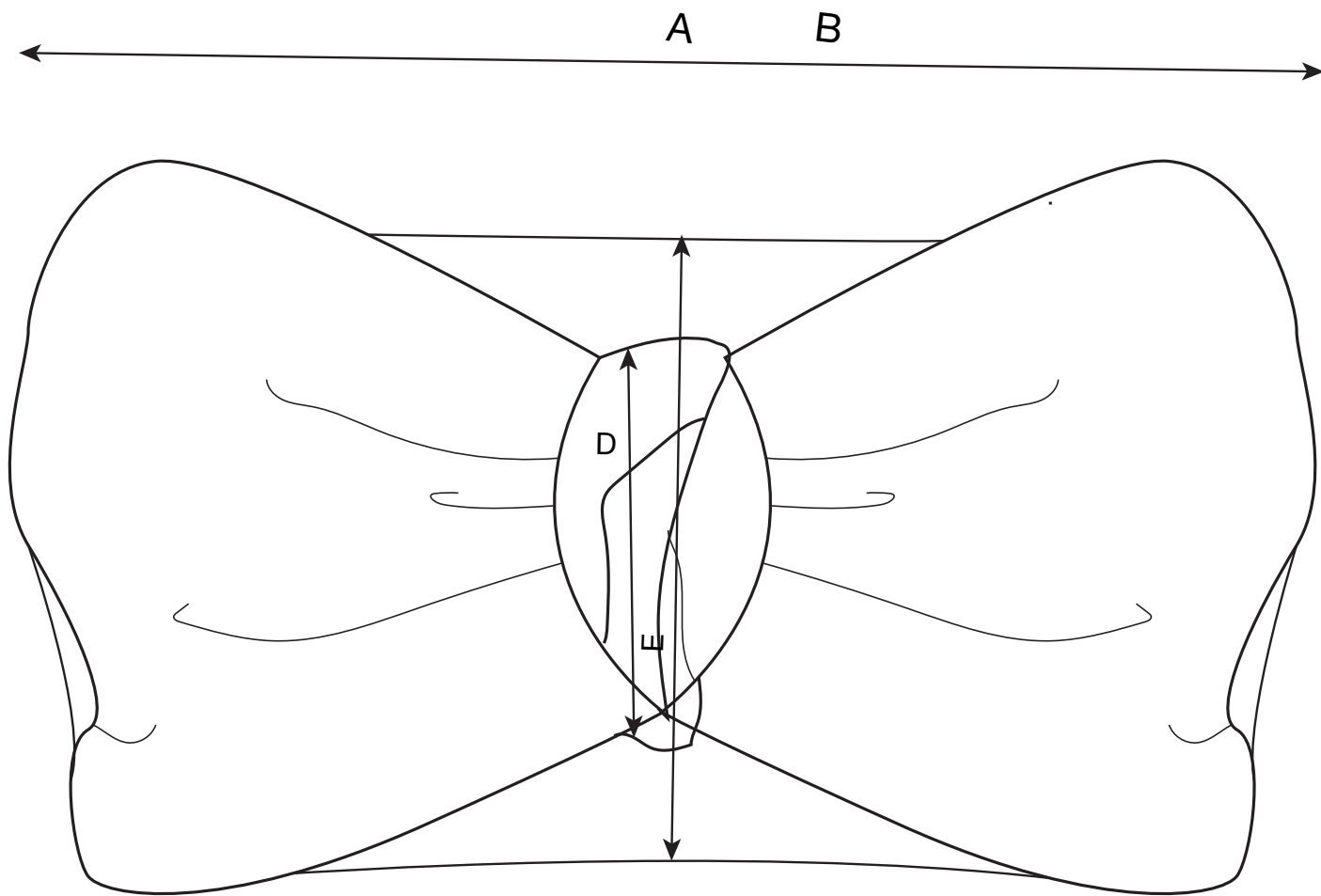

**FICHE TECHNIQUE//////////**

Appellation	Lettre	Mesure cm	
<b>HSP</b>	A		
<b>Dos</b>	B		
<b>Moitié de noeud</b>	E		
<b>Largeur en tout</b>	C		
<b>Hauteur du dos</b>	G		
<b>Hauteur du noeud</b>	D		
	I		